

深圳市色彩光电有限公司

Shenzhen LED Color Co.,LTD

Add: 4-5/F Dadong Ming Technology Park, Yuequn Road, Changzhen, Guangming District, Shenzhen, China

Tel: +86-0755-27350605 Fax: +86-0755-23245913 Web: www.szledcolor.com

Product specification

Product No.: LC8823-3535

Description: 3535 SMD 0.3W intelligent external control LED

Date: 2020-9-1

Document No.: SPC-TOP-A/20701

Version No.: A/20



Customer review			LED Color		
Approved	Confirm	Make	Approved	Confirm	Make
			Mr Zhao	Mr Zhao	Mr Cheng
<input type="checkbox"/> Accept		<input type="checkbox"/> Not accept	Date: 2020-9-1		

深圳市色彩光电有限公司

Shenzhen LED Color Co.,LTD

1.Product description:

LC8823-3535 is an intelligent externally controlled LED that integrates a control circuit and a light-emitting circuit. Its appearance is the same as a 3535 LED . Each LED is a pixel. The LED contains an intelligent digital interface data latch signal circuit. , Power supply voltage regulator circuit, built-in constant current circuit, data regeneration circuit, high precision RC oscillator, output drive adopts patented PWM technology, which effectively guarantees the color consistency of the each pixel.

The data transmission adopts clock and data signal protocol, which has long transmission distance and strong anti-interference ability.

LC8823-3535 has the advantages of low voltage drive, environmental protection and energy saving, high brightness, large scattering angle, good consistency, long life and so on. The control circuit is integrated inside the LED, which makes the application circuit design easier, less original parts, and small in size. Beautiful, easier to install.

2.Main application areas:

LED full-color luminous character string light, LED full-color soft and hard light bar, LED point light source, LED pixel screen, LED special-shaped screen, LED full-color module, car lights, shoe lights, toys, audio, home appliances, and various electronics product.

3.Feature:

- Smart SMD integrates high-quality external control double-wire serial cascaded constant current IC.
- The control circuit and chip are integrated in SMD components to form a complete externally controlled pixel point, color,color temperature, uniform effect and high consistency,and the default output constant current value OUTR/OUTG/OUTB is 17MA
- Built-in power-on reset and power-down reset circuits, the light does not light up after power-on.
- The PWM refresh frequency is 27KHz.
- Two-wire data transmission, unlimited cascading, the maximum serial input data frequency is 32MHz
- Grayscale adjustment circuit (256-level grayscale is adjustable).
- No data input, zero power consumption when the light is off.
- Vertical SMD surface mount package, suitable for all SMT assembly and soldering processes.
- Moisture-proof grade: LEVEL5a.
- CE, RoHS certification

深圳市色彩光电有限公司

Shenzhen LED Color Co.,LTD

4.Package size drawing:

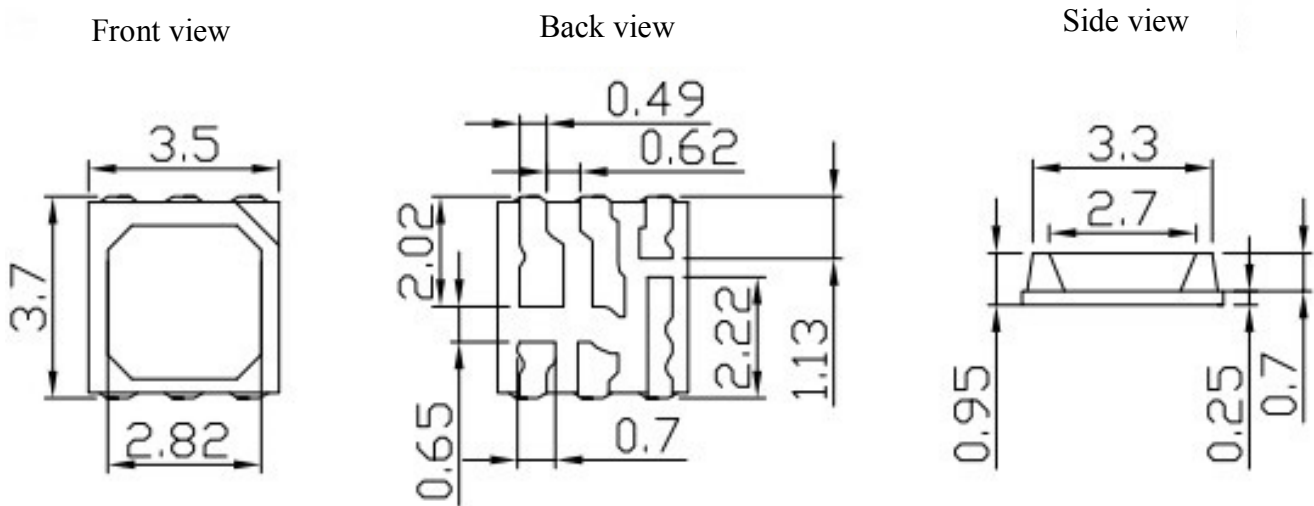

Remarks: All dimensions are marked in millimeters and the tolerance is ± 0.15 mm, unless otherwise specified.

5.Pin diagram and function description:

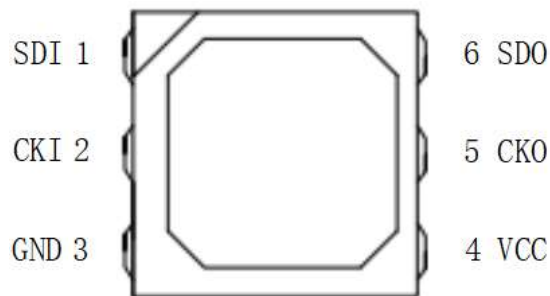

No.	Symbol	Function description
1	SDI	Data input port
2	CKI	Clock input port
3	GND	Ground
4	VCC	Power supply
5	CKO	Clock output port
6	SDO	Data output port for cascading

深圳市色彩光电有限公司

Shenzhen LED Color Co.,LTD

6.RGB chip characteristic parameter Ta=25℃:

Color	Wavelength(nm)	Light Intensity (mcd)	Lumen (LM)
Red	620-630	480-800	1.5-2.5
Green	520-535	1400-1800	4.5-5.5
Blue	460-475	300-600	1.0-2.0

7.Electrical parameters (limit parameters, unless otherwise specified, Ta=25℃):

Parameter	Symbol	Range	Unit
Voltage	VDD	-0.5~+5.5	V
Logic input voltage	VI	GND-0.3~VDD+0.3	V
Working temperature	Topt	-40~+85	℃
Storage temperature	Tstg	-50~+85	℃
ESD pressure (Device mode)	VESD	200	V
ESD pressure (body mode)	VESD	4000	V

8.Electrical characteristics (if no special instructions, VDD=5V, Ta=25℃):

Parameter	Symbol	Min	Typical	Max	Unit	Test Conditions
The chip supply Voltage	VDD	-	5.0	-	V	-
R/G/B port output current	IOUT_R	-	17	20	mA	-
Clock high level width	TCLKH	-	-	>30	ns	-
Clock low level width	TCLKL	-	-	>30	ns	-
Data creation time	TSETUP	-	-	>10	ns	-
PWM output frequency	Fpwm	-	27	-	KHz	-
Static current	IDD	-	1	-	uA	-

深圳市色彩光电有限公司

Shenzhen LED Color Co.,LTD

9.Data communication protocol description (the protocol uses a two-wire protocol):

(1) Encoding protocol description

SDI	32pcs 0	LED 1	LED 2	LED 3	-----	LED N	32pcs 1
	Start Frame	Data Frame	Data Frame	Data Frame		Data Frame	End Frame

Start Frame 32Bits	0000 0000	0000 0000	0000 0000	0000 0000
	8Bits	8Bits	8Bits	8Bits

Data Frame	111	Brightness adjustment	BLUE	GREEN	RED
	3Bits	5Bits	8Bits	8Bits	8Bits

High priority
High priority
High priority
High priority

End Frame	1111 1111	1111 1111	1111 1111	1111 1111
	8Bits	8Bits	8Bits	8Bits

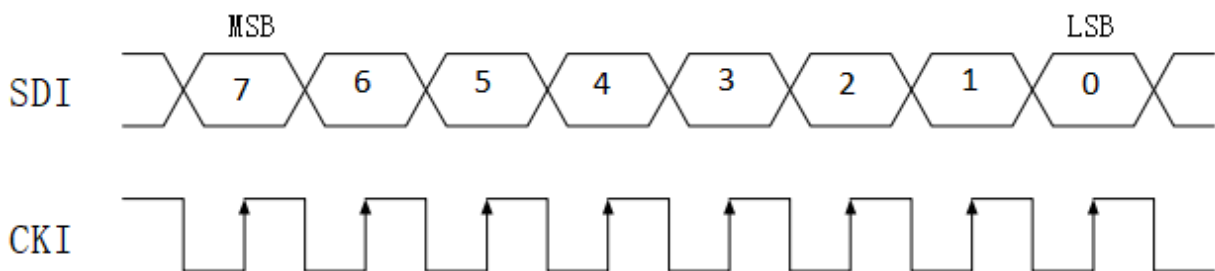

深圳市色彩光电有限公司

Shenzhen LED Color Co.,LTD

(2) 256 gray level

DIGIT	DUTY RATIO
MSB. . . . LSB	
0000 0000	0/256
0000 0001	1/256
0000 0010	2/256
1111 1101	253/256
1111 1110	254/256
1111 1111	255/256

(3) Brightness adjustment (control the current of the three ports OUTR\OUTG\OUTB at the same time)

DIGIT	CURRENT ADJUSTMENT
MSB. . . . LSB	
00000	0/31
00001	1/31
00010	2/31
11101	29/31
11110	30/31
11111	31/31

(4) Refresh rate

Frame rate=1/((64+(32*points))*CKI period) (unit frame/second)

For example: 1024 points, CKI frequency is 1MZH, then frame rate = 30 frames/second.

(5) Data structure (Ta=25°C):

B7	B6	B5	B4	B3	B2	B0	G7	G6	G5	G4
G3	G2	G1	G0	R7	R6	R4	R3	R2	R1	R0

Note: The high bit is sent first, and the data is sent in the order of (B7 → B6 →R0)

10. Typical application circuit:

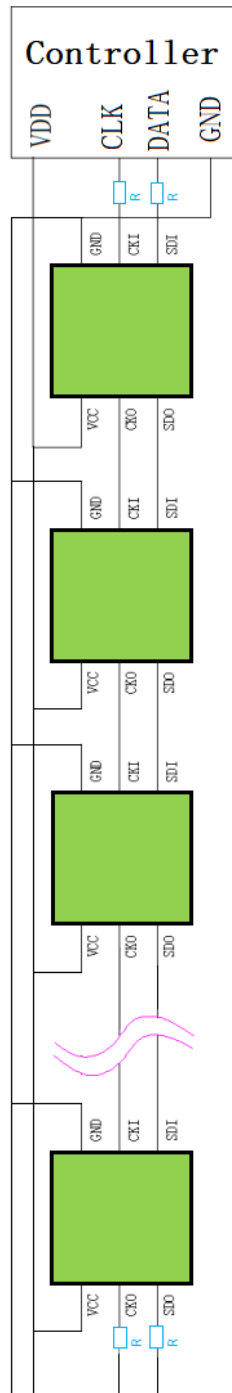

The signal input and output terminals of the product need to be connected in series with a protective resistor R when necessary when necessary. The size of the protective resistor R depends on the number of cascaded led. The more the number of cascades, the smaller the R. Generally, a value between 27-51 ohms is recommended. The recommended value is around 33 ohms.

深圳市色彩光电有限公司

Shenzhen LED Color Co.,LTD

11. Typical optical characteristic curve:

Welding temperature VS Forward current

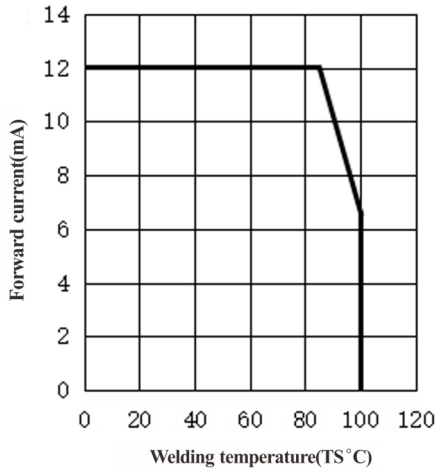

Forward current VS Relative light intensity

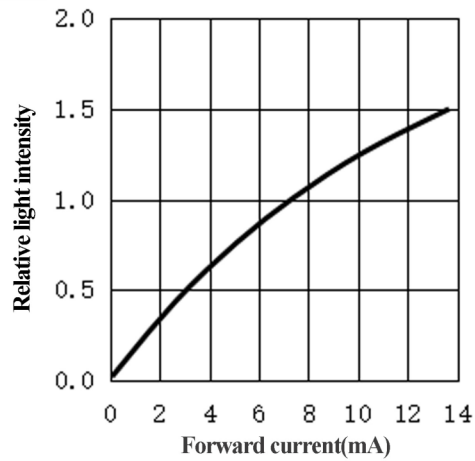

Forward voltage VS Forward current

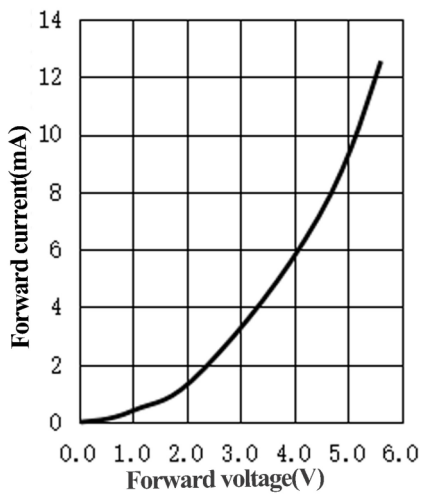

Ambient temperature VS Rrelative light intensity

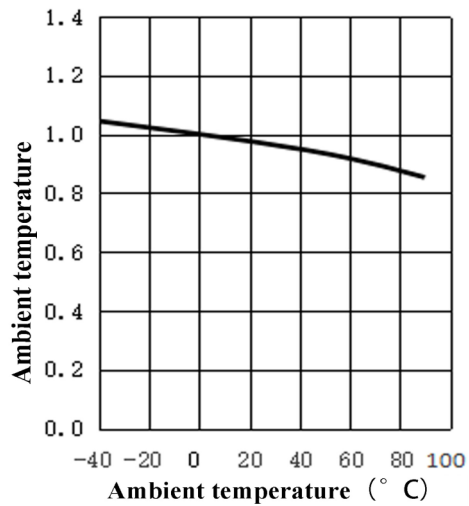

Relative spectral distribution chart

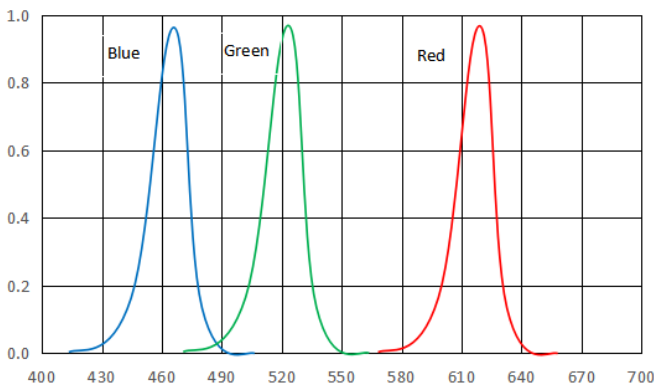

Relative spectral distribution chart

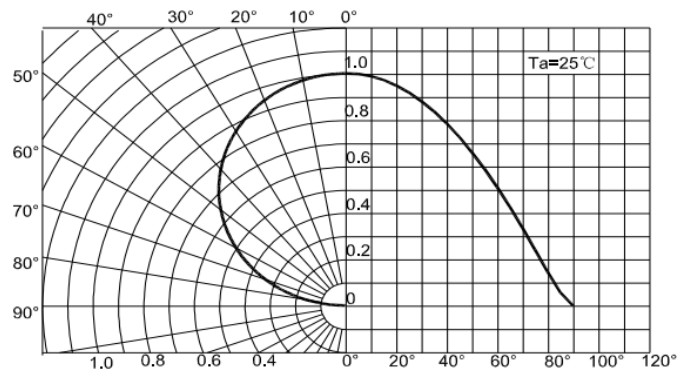

深圳市色彩光电有限公司

Shenzhen LED Color Co.,LTD

12. Reliability Test :

Test Item	Test Conditions	Duration/Cycle	Quantity	Ac/Re
Resistance to Soldering Heat	260°C/10sec	3 Min.	22PCS	0/1
Temperature cycle	-40°C 30min ↑↓25°C(5min) 100°C 30min	200 cycles	22PCS	0/1
Thermal Shock	-40°C 20min ↑↓ 10sec 100°C 20min	300 cycles	100PCS	0/1
High temperature and humidity storage	Ta=85°C RH=85%	1000 hours	22PCS	0/1
High Temperature Storage	Ta=100°C	1000 hours	22PCS	0/1
Low Temperature Storage	Ta=-40°C	1000 hours	22PCS	0/1
Room Temperature Operation life	Ta=25°C IF=Typical value	1000 hours	22PCS	0/1

深圳市色彩光电有限公司

Shenzhen LED Color Co.,LTD

13.Packing specifications:

Carrier tape specifications (unit: mm)

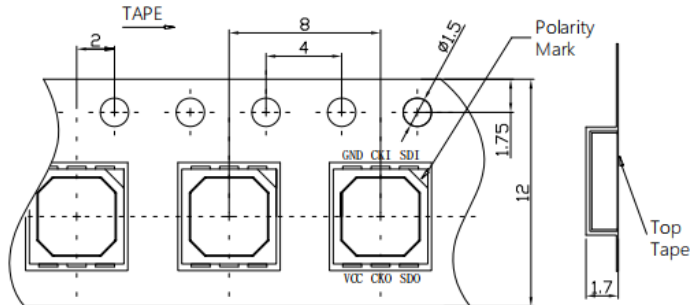

Reel size:

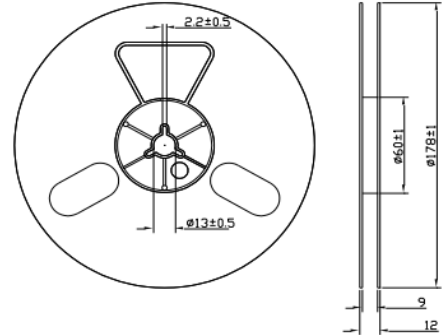

Moisture-proof bag packaging:

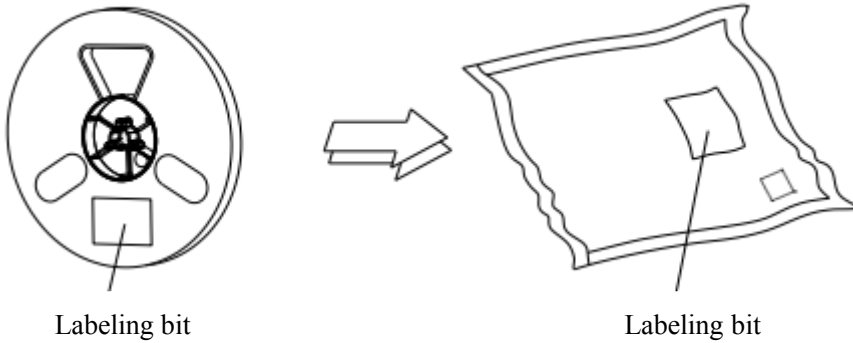

Note: The marked tolerance is ± 0.1 mm, unit: mm

Label description:

PRODUCT No: Product model
 QUANTITY: Package quantity
 LOT NO: Order number
 DATE: Production date

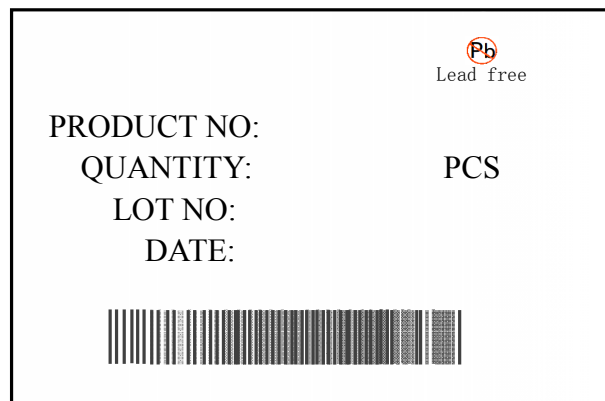

Label diagram

Note: SMD3535 series packaging standard is 1500PCS/bag, except for special requirements.

深圳市色彩光电有限公司

Shenzhen LED Color Co.,LTD

SMD LED Usage Notice

Thank you for using the LED chip of Shenzhen LED Color Co., Ltd.. In order to enhance your understanding of the characteristics of our products, and to facilitate you to quickly grasp the basic operations of the products, in order to minimize or avoid unnecessary products caused by human factors damaged, so that it can better serve your production, specially for some standard use in the process of use for corresponding instructions. At the same time even if the same specification LED, its reliability and design level in the actual application field, operation mode, use conditions They are all related. This instruction manual cannot cover all the problems that customers may encounter during use. We apologize for the inconvenience caused!

1.1 Generally, LEDs are used in the same way as other electronic components. In order to allow customers to better use our LED products, please refer to the following LED protection precautions.

1.2 Transportation and storage

Smart LED is packaged in a moisture-proof and anti-static aluminum foil bag. Avoid squeezing or piercing the packaging bag during transportation, and take necessary anti-static protection measures. Before the product is produced, if air leakage or damage is found, please stop using it directly and do the necessary use after high temperature dehumidification. In the process of product replacement, placement, finished product shipment, and installation, care should be taken to prevent external force from colliding and squeezing the LED, causing external force to damage the LED.

If the aluminum foil bag has been discovered before production, unsealed, damaged, or leaked, please return it to the original factory for dehumidification testing in time, and never use it online. Smart LED is a humidity-sensitive element. Packaging the LED in an aluminum foil bag is to prevent the LED from absorbing moisture during transportation and storage. A desiccant is placed in the packaging bag to absorb moisture. If the LED absorbs moisture, the moisture will expand when the LED is reflowed, causing the gel to separate from the bracket, or damage the key alloy wire, causing the product to fail. For this reason, the vacuum moisture-proof packaging is to avoid moisture in the packaging bag. The moisture-proof grade of this product is LEVEL5a.

Diagram 1: Definition of Material Moisture Resistance Level (MSL) specified by IPC/JEDEC J-STD-020

Moisture Resistance level	Workshop life after unpacking	
	Time	Condition
LEVEL1	Unlimited	$\cong 30^{\circ}\text{C}/85\% \text{ RH}$
LEVEL2	1year	$\cong 30^{\circ}\text{C}/60\% \text{ RH}$
LEVEL2a	4weeks	$\cong 30^{\circ}\text{C}/60\% \text{ RH}$
LEVEL3	168hours	$\cong 30^{\circ}\text{C}/60\% \text{ RH}$
LEVEL4	72hours	$\cong 30^{\circ}\text{C}/60\% \text{ RH}$
LEVEL5	48hours	$\cong 30^{\circ}\text{C}/60\% \text{ RH}$
LEVEL5a	24hours	$\cong 30^{\circ}\text{C}/60\% \text{ RH}$
LEVEL6	Take out and use	$\cong 30^{\circ}\text{C}/60\% \text{ RH}$

1.3.Storage before opening

In order to avoid redundancy failure caused by moisture absorption, it is necessary to take good measures to store and prevent moisture before LED products are produced.

深圳市色彩光电有限公司

Shenzhen LED Color Co.,LTD

If the vacuum moisture-proof bag is not opened, the storage time of Smart SMD components is within 1 month under 30°C/ 60%RH. (Subject to the date of the label, use the vacuum package without air leakage. There are certain differences in the storage time of different moisture-proof materials or packaging. The specific storage time is subject to the specification or the packaging bag.) It is recommended before use Do not open the vacuum packaging bag.

1.4. SMT production control

After opening the packaging bag, the materials shall be strictly controlled within the allowable range of maximum humidity and operating time specified in diagram 1. As long as the material is exposed to the environment described in diagram 1, it must be used in the workshop. After opening the packaging bag and affixed to the PCB, the welding work should be completed within 2H. It is not recommended to stick the material on the PCB, and to stay in the workshop for a long time without SMT furnace operation, so as to prevent the material from absorbing the moisture in the solder paste and causing bad risks.

1.5. Moisture-proof storage of unused materials

If a roll of led material has not been used up at one time, and the temperature and humidity of the workshop are within the limited conditions ($\leq 30^{\circ}\text{C}/60\%\text{RH}$), and the exposure time of the element in the air does not exceed 2H, the remaining materials should be put into desiccant together. Vacuum and seal storage. Otherwise, the material must be baked and dehumidified at low humidity, and the dehumidified material can be repackaged to restart the calculation of time.

1.6. Moisture-proof control for the assembled LED components

For products that require a secondary SMT process or high temperature, the necessary moisture-proof treatment should also be done before the secondary welding after the completion of the first welding. Exposure to ($\leq 30^{\circ}\text{C}/60\%\text{RH}$) conditions, the longest No more than 2H. If the time between the second high temperature production is longer, the material after the first welding must be dehumidified (bake in an oven at $70^{\circ}\text{C}\pm 5^{\circ}\text{C}$ for no less than 12 hours), and then vacuum sealed , or store the product in a constant temperature and humidity oven in a drying oven. Before the second high temperature production, do dehumidification work (bake in an oven at $70^{\circ}\text{C}\pm 5^{\circ}\text{C}$ for no less than 12 hours) to ensure that the product is not damp before the high temperature process. Low-humidity baking conditions: $70^{\circ}\text{C}\pm 5^{\circ}\text{C}$ for no less than 12 hours; high-temperature baking conditions: $130^{\circ}\text{C}\pm 5^{\circ}\text{C}$ for 5 hours, and the total number of normal reflow soldering operations does not exceed 3 times.

For products subjected to extrusion process or high-temperature protection treatment, it is recommended that the necessary dehumidification work be done before the product is protected. Bake in an oven at $130^{\circ}\text{C} \pm 5^{\circ}\text{C}$ for 5 hours to eliminate the moisture absorbed by the product during testing, aging, and transportation. In order to avoid the product after the protective treatment, the moisture wrapped on the surface of the material will slowly enter the material and cause the product to fail.

1.7. Reflow soldering

It is verified by us using the parameters listed below that the surface mount LED meets the JEDEC J-STD-020C standard. As a general guideline, we recommends that customers follow the soldering temperature curve recommended by the manufacturer of the solder paste used.

Please note that this general guideline may not apply to all PCB designs and reflow soldering equipment configurations

深圳市色彩光电有限公司

Shenzhen LED Color Co.,LTD

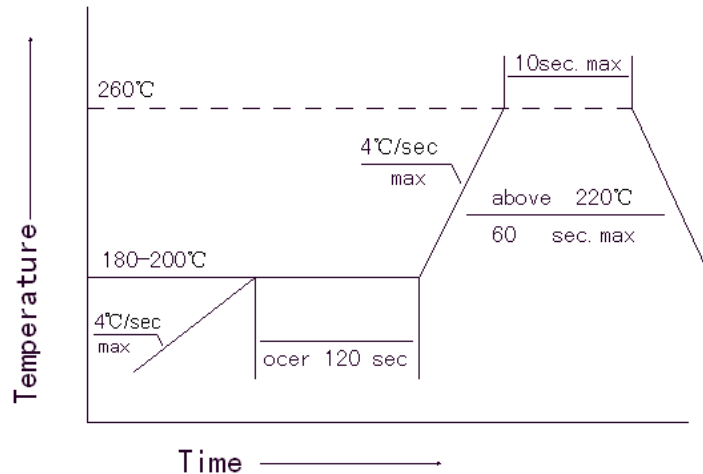

Profile Feature	Lead-Based Solder	Lead-Free Solder
Average Ramp-Up Rate (Ts max to Tp)	3 °C/second max	3 °C/second max
Preheat: Temperature Min (Ts min)	100°C	150°C
Preheat: Temperature Min (Ts max)	150°C	200°C
Preheat: Time (ts min to ts max)	60-120 seconds	60-180 seconds
Time Maintained Above: Temperature (TL)	183 °C	217 °C
Time Maintained Above: Time (t L)	60-150 seconds	60-150 seconds
Peak/Classification Temperature (T P)	215 °C	240 °C
Time Within 5°C °C of Actual Peak Temperature (tp)	<10 seconds	<10 seconds
Ramp-Down Rate	6 °C/second max	6 °C/second max
Time 25 °C °C to Peak Temperature	<6 minutes max	<6 minutes max

Note: All the Note: All the temperature refer to topside of the package, measured on the package body surface. When welding, do not forcefully press the surface of the colloid when the material is heated.

1.8.SMT nozzle requirements:

(red circle refers to the inside diameter of the nozzle, see picture 1 and picture 2)

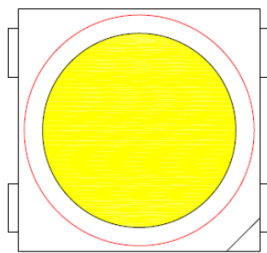

OK (the inside diameter of the nozzle is larger than the light-emitting area of the led)

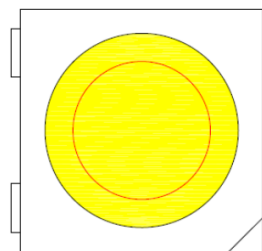

NG (the inside diameter of the nozzle is smaller than the lighting area of the led)

深圳市色彩光电有限公司

Shenzhen LED Color Co.,LTD

In order to prevent air pressure leakage, the outer diameter of the SMD nozzle should not exceed the size of the LED, and the inner diameter of the nozzle should be as large as possible. The tip of the nozzle should be made of soft material to prevent scratching or damaging the LED gel surface during suction. The size of the component must be Accurate in the pick and place machine.

1.9. Material picking method: use tweezers to pick up the material. Do not press the colloid or sharp objects to puncture the colloid. The materials cannot be stacked.

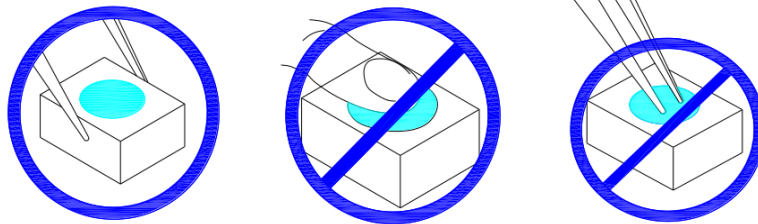

Do not stack products together, it may damage the internal circuit,

Cannot be used in acidic places with $\text{PH} < 7$

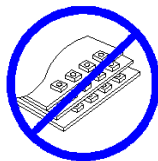

2.0. When we need to use the external sealant to coat the LED products, we should ensure that the external sealant matches the LED packaging glue, because most of the LED packaging glue is silica gel and epoxy glue, it has oriented oxidation and aligned moisture absorption. It is necessary to prevent the external sealing material from entering the LED to cause damage to the LED. The content of a single bromine element is required to be less than 900PPM, and the content of a single chlorine element is required to be less than 900PPM. When applying LED products, the total content of bromine and chlorine in the outer sealant must be less than 1500PPM.

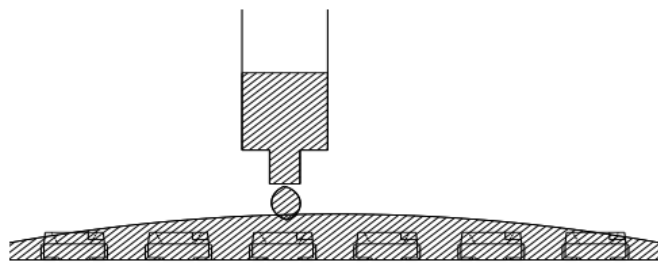

2.1. Welding

For manual soldering, it is recommended to use an electric soldering iron with a power of not more than 60W, and control the temperature of the soldering iron not to exceed 350°C . The electric soldering iron stays on the bracket pin for no more than 3 seconds each time. If you need to repeatedly solder, the interval stay time is not less than 3 seconds to avoid long time high temperature damage to the LED.

深圳市色彩光电有限公司

Shenzhen LED Color Co.,LTD

During the soldering process, please do not touch or squeeze the surface of the LED to avoid damage to the LED interior. At the same time, please pay attention to avoid scalding and other damages to the LED surface colloid and PPA by the soldering iron.

2.2. Thermal design requirements

For LED products, the design of heat dissipation is very important. When designing the product, please consider the heat generated by the LED, the thermal resistance of the PCB board, the density of the LED arrangement, and the input electric power will all increase the temperature.

In order to avoid excessive heat generation, it is necessary to ensure that the LED runs within the maximum specification range required in the product specification. When setting the driving power of the LED, the highest ambient temperature should be considered.

The maximum working temperature of the product cannot exceed 50°C (ie $\leq 50^{\circ}\text{C}$, which refers to the operating temperature at the GND of the LED pin).

2.3. Anti-static and surge protection for IC devices

Static electricity and surges can damage the LED products of IC devices. Therefore, corresponding protective measures must be taken. The signal input and output ports of the IC device are connected with protective resistors in series to prevent the product from failing due to surge or electrostatic shock.

In order to protect the LED products of IC devices, no matter what time or occasion, as long as you touch the LED, you need to wear an anti-static wristband and anti-static gloves. All equipment and instruments must be grounded.

It is recommended that each product is inspected before shipment, and there should be related electrical tests to select defective products caused by static electricity. When designing the circuit, consider eliminating the possibility of surges from harming LEDs.

2.4. Special statement

1. If it is used outside of the specification, our company will not be responsible for any problems.
2. The LED can emit a strong light that can damage the eyes. Take precautions and do not look directly at the LED light with the naked eye for too long.
3. Before mass use, you should communicate with relevant personnel of our company to understand more detailed specifications.
4. If the shape and specifications of LED products are changed, please forgive me for not being able to inform in time.